

LOC	DIST
-	-

REVISIONS					
P	LTR	DESCRIPTION	DATE	DWN	APVD
	NC	NEW RELEASE PER E.O. A14874	21JUL1995	-	RDR
	A	REDRAWN AND REVISED PER E.O. P17133	15FEB2001	-	RDR
	AI	REVISED PER PCN-22-136768	21APR2022	MR	IG

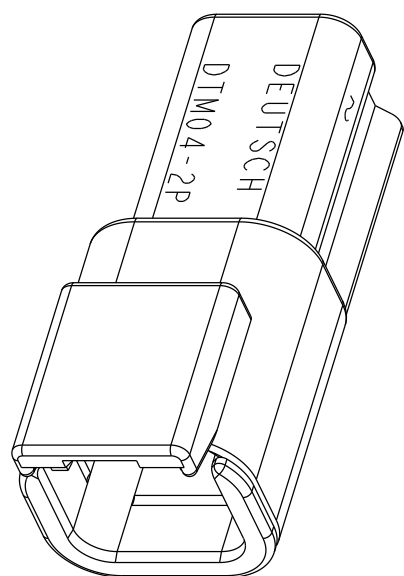

3D VIEW

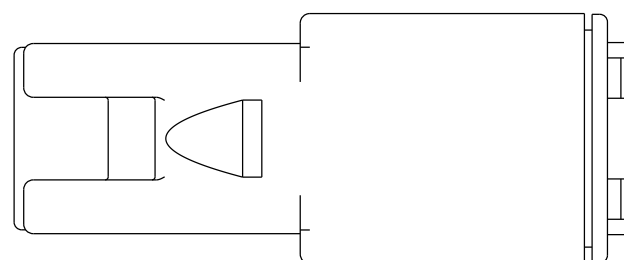
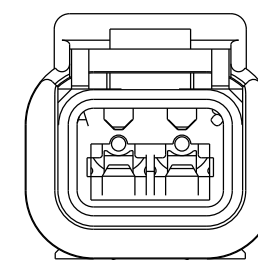
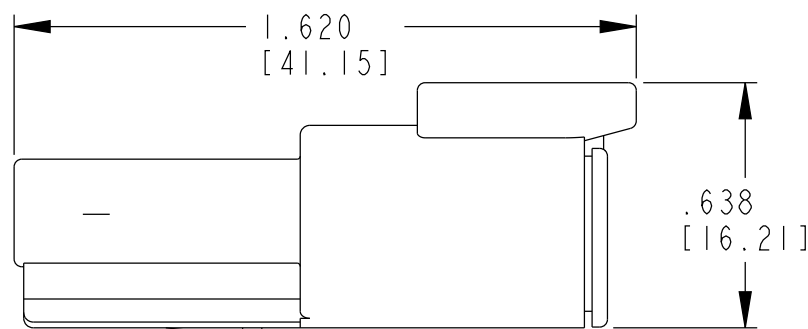
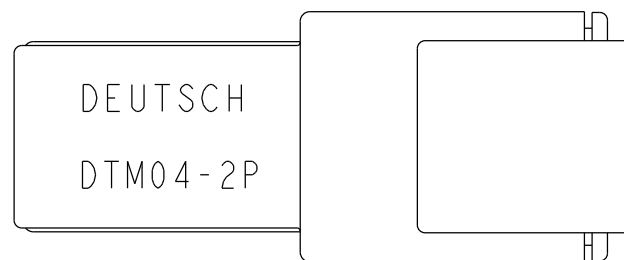
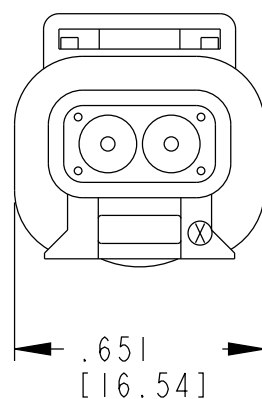

RECEPTACLE HOUSING

CONTACT SIZE	MIN. INSUL. O.D.	MAX. INSUL. O.D.	WIDE RANGE [mm ²] REF ONLY
20	.053 [1.35]	.120 [3.05]	16-20 AWG [1.0-0.2]

6. MATERIAL: HOUSING: PA66 GF15 (GRAY)
GROMMET: VMQ (RED/ORANGE)

5. THIS RECEPTACLE MATES WITH DTM06-2S-XXXX PLUG.
(XXXX = ALL MODIFICATIONS)

4. FOR CONTACT AND WIRE PERFORMANCE AND APPLICATION CHARACTERISTICS SEE ENVELOPE DRAWING 0425-015-0000.

3. ITEM SOLD SEPARATELY: WM-2P.

2. DELETED.

1. DELETED.

NOTE: UNLESS OTHERWISE SPECIFIED

THIS DRAWING IS A CONTROLLED DOCUMENT.

DIMENSIONS:
INCHES [mm]

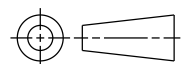

TOLERANCES UNLESS OTHERWISE SPECIFIED:

0 PLC	±-
1 PLC	±
2 PLC	±
3 PLC	±.025 [0.64]
4 PLC	±
ANGLES	±-

MATERIAL



FINISH

-

DWN 05FEB2001

J. APOSTOL

CHK 13FEB2001

V. TOMSA

APVD 15FEB2001

R. REED

PRODUCT SPEC

108-151010

APPLICATION SPEC

114-151010

WEIGHT 5 G

NAME
RECEPTACLE 2 PIN CONT. #20
DTM SERIES

SIZE	CAGE CODE	DRAWING NO	RESTRICTED TO
A3	-	©-DTM04-2P	-

Customer Drawing SCALE 2:1 SHEET 1 OF 1 REV AI

